

LAMPIRAN

(*Flow chart* Sistem Usulan)

Flowchart Program**- Flowchart Halaman Index**

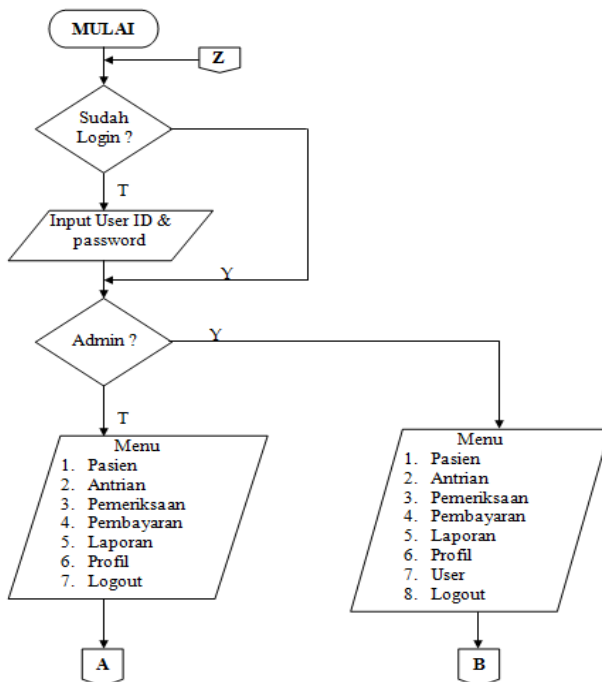
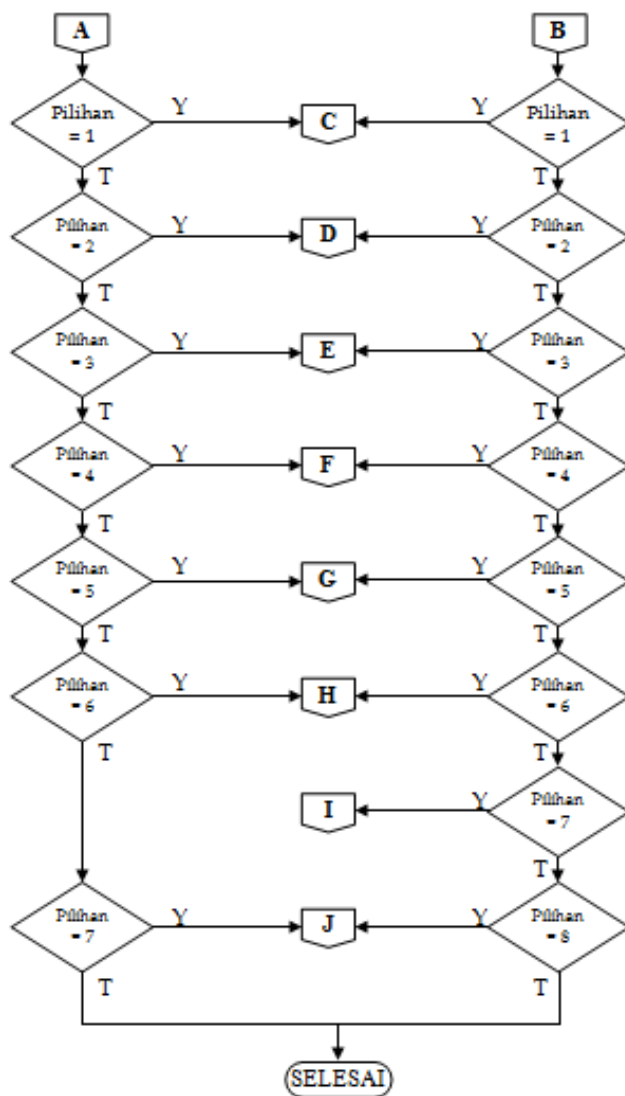

- Flowchart Halaman Pasien

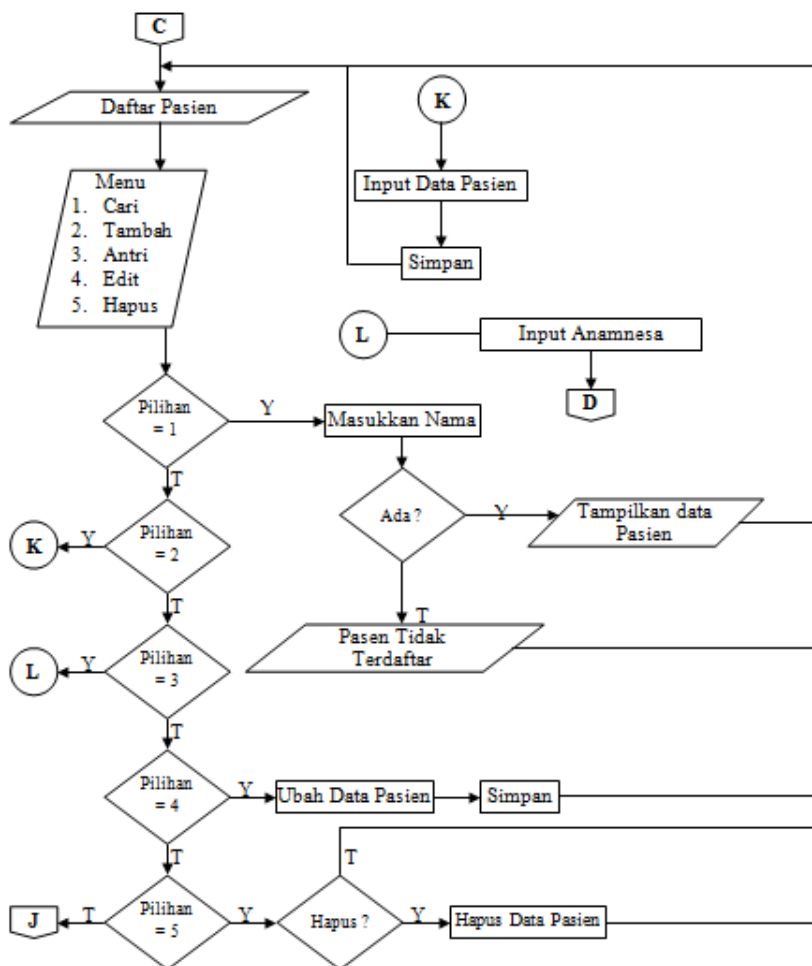

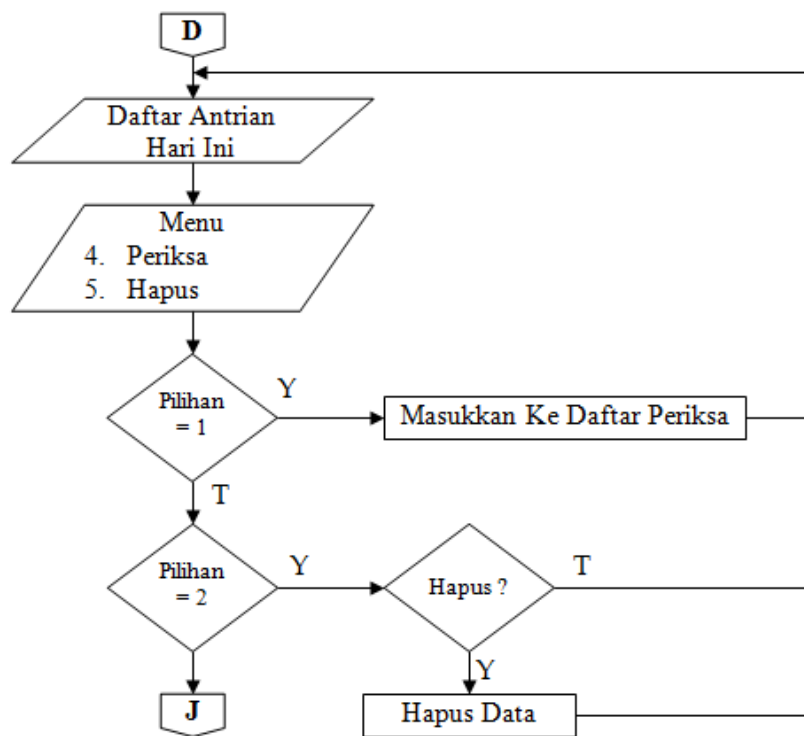
- *Flowchart* Halaman Antrian

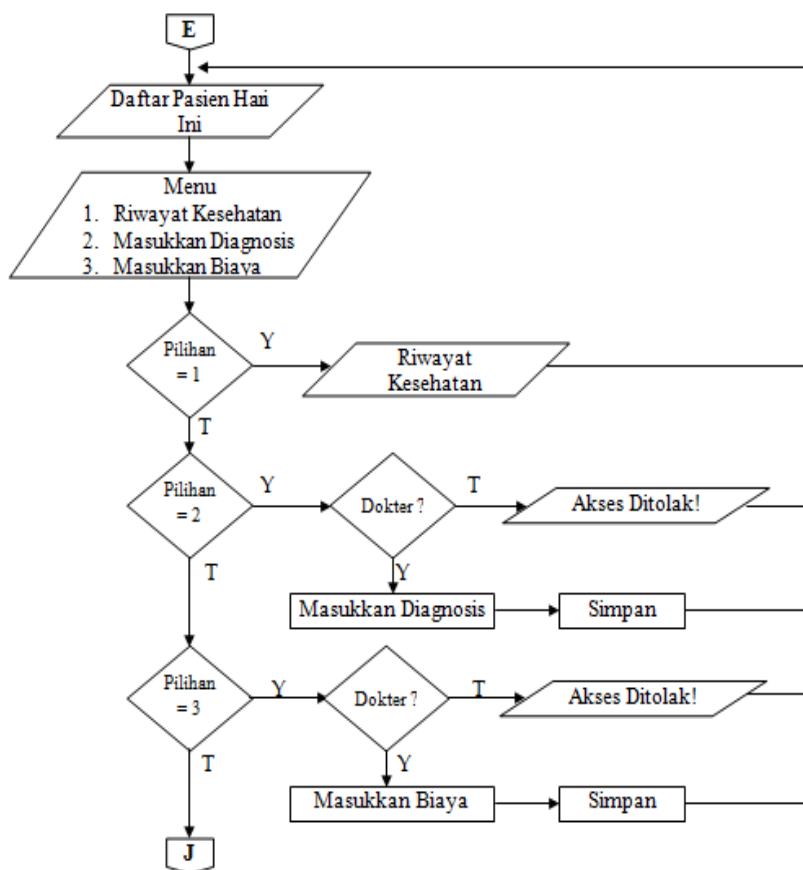
- *Flowchart* Halaman Pemeriksaan

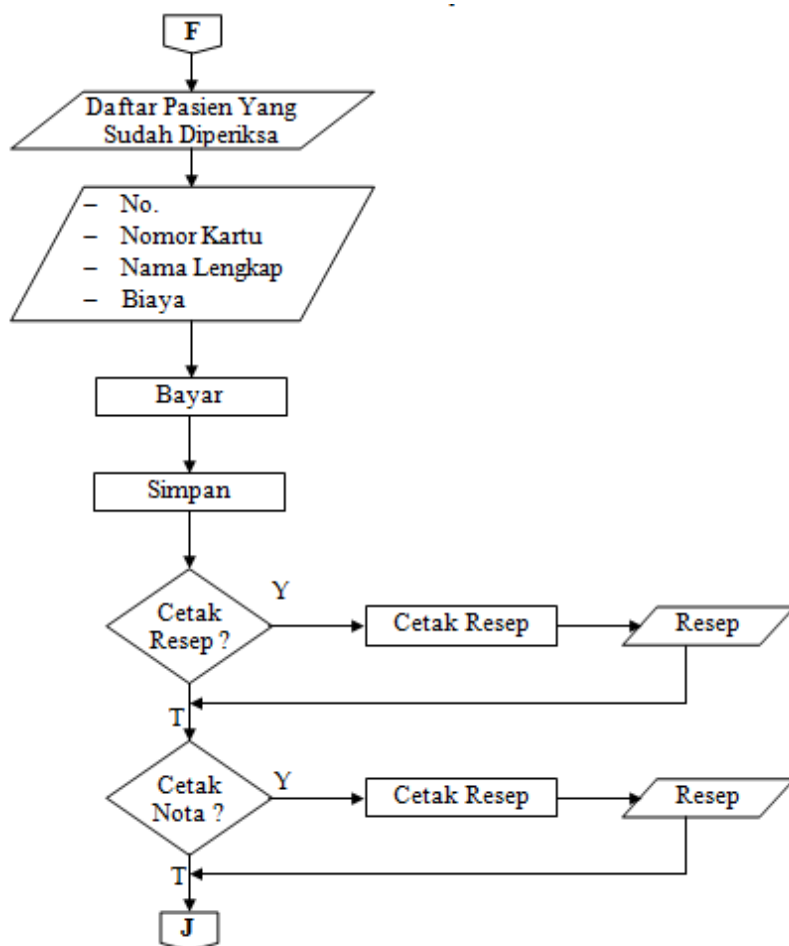
- *Flowchart Halaman Pembayaran*

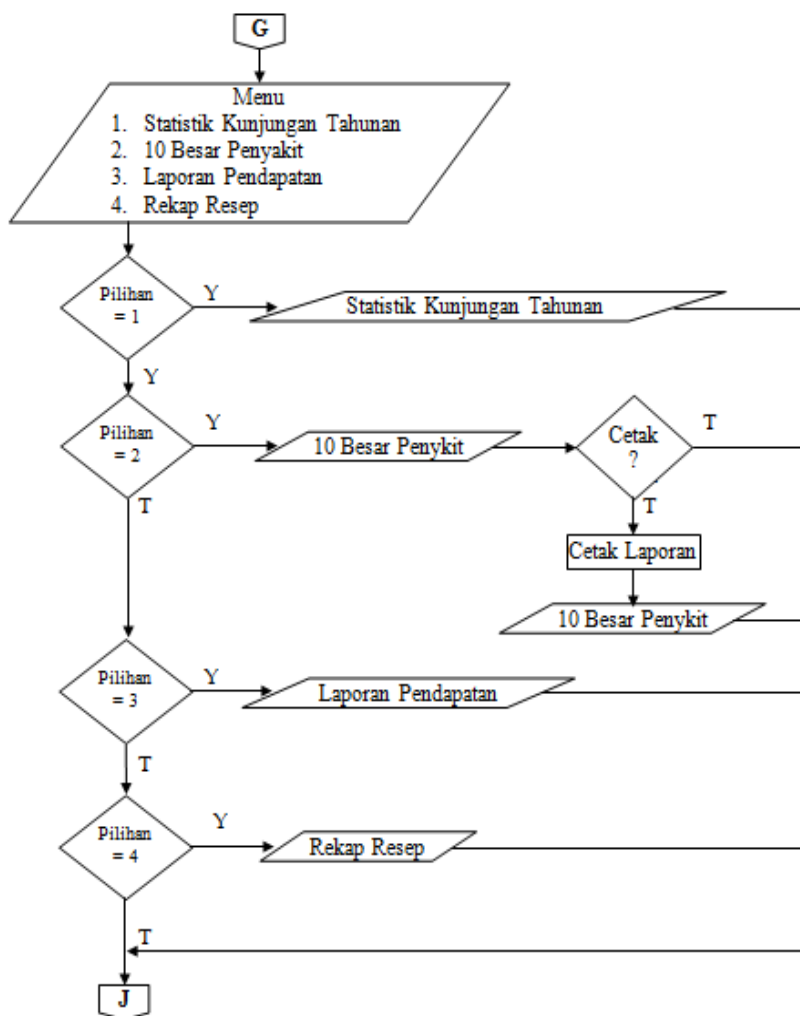
- *Flowchart* Halaman Laporan

- *Flowchart Halaman Profile*

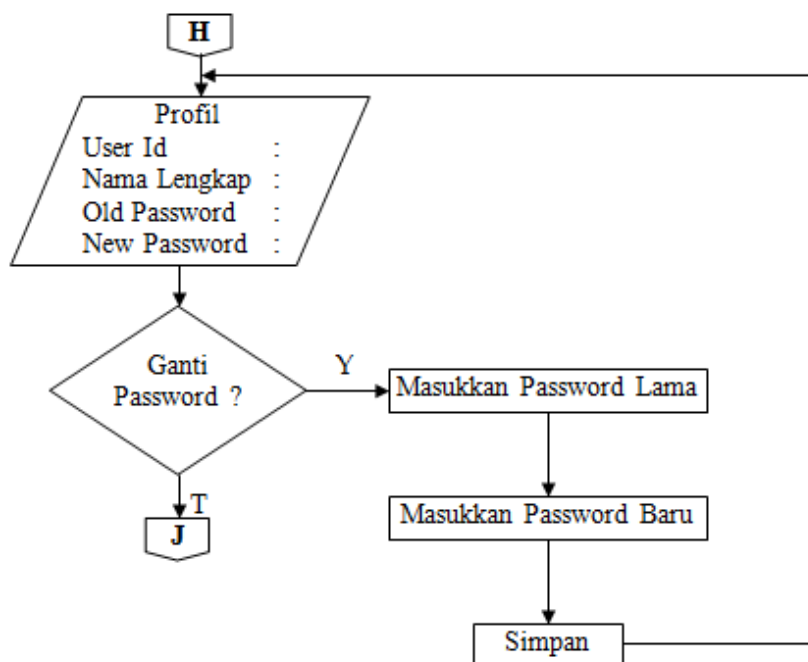

- *Flowchart* Halaman User